

LM1949 Injector Drive Controller

Check for Samples: [LM1949](#)

FEATURES

- Low Voltage Supply (3V–5.5V)
- 22 mA Output Drive Current
- No RFI Radiation
- Adaptable to All Injector Current Levels
- Highly Accurate Operation
- TTL/CMOS Compatible Input Logic Levels
- Short Circuit Protection
- High Impedance Input
- Externally Set Holding Current, I_H
- Internally Set Peak Current ($4 \times I_H$)
- Externally Set Time-Out
- Can be Modified for Full Switching Operation
- Available in Plastic 8-Pin PDIP

APPLICATIONS

- Fuel Injection
- Throttle Body Injection
- Solenoid Controls
- Air and Fluid Valves
- DC Motor Drives

DESCRIPTION

The LM1949 linear integrated circuit serves as an excellent control of fuel injector drive circuitry in modern automotive systems. The IC is designed to control an external power NPN Darlington transistor that drives the high current injector solenoid. The current required to open a solenoid is several times greater than the current necessary to merely hold it open; therefore, the LM1949, by directly sensing the actual solenoid current, initially saturates the driver until the “peak” injector current is four times that of the idle or “holding” current (Figure 19–Figure 22). This guarantees opening of the injector. The current is then automatically reduced to the sufficient holding level for the duration of the input pulse. In this way, the total power consumed by the system is dramatically reduced. Also, a higher degree of correlation of fuel to the input voltage pulse (or duty cycle) is achieved, since opening and closing delays of the solenoid will be reduced.

Normally powered from a $5V \pm 10\%$ supply, the IC is typically operable over the entire temperature range (-55°C to $+125^\circ\text{C}$ ambient) with supplies as low as 3 volts. This is particularly useful under “cold crank” conditions when the battery voltage may drop low enough to deregulate the 5-volt power supply.

The LM1949 is available in the plastic PDIP, (contact factory for other package options).

Typical Application

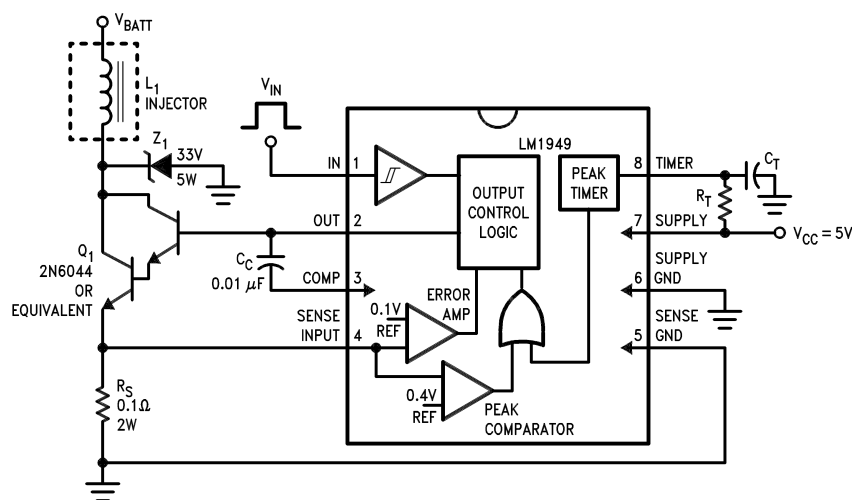

Figure 1. Typical Application and Test Circuit



Please be aware that an important notice concerning availability, standard warranty, and use in critical applications of Texas Instruments semiconductor products and disclaimers thereto appears at the end of this data sheet.

All trademarks are the property of their respective owners.

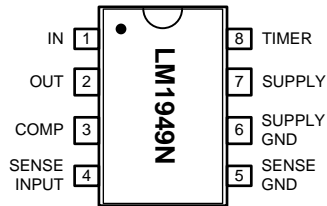

Figure 2. Package Number P0008E



These devices have limited built-in ESD protection. The leads should be shorted together or the device placed in conductive foam during storage or handling to prevent electrostatic damage to the MOS gates.

Absolute Maximum Ratings ⁽¹⁾⁽²⁾

Supply Voltage	8V
Power Dissipation ⁽³⁾	1235 mW
Input Voltage Range	-0.3V to V _{CC}
Operating Temperature Range	-40°C to +125°C
Storage Temperature Range	-65°C to +150°C
Junction Temperature	150°C
Lead Temp. (Soldering 10 sec.)	260°C

- (1) Absolute Maximum Ratings indicate limits beyond which damage to the device may occur.
- (2) If Military/Aerospace specified devices are required, please contact the Texas Instruments Sales Office/ Distributors for availability and specifications.
- (3) For operation in ambient temperatures above 25°C, the device must be derated based on a 150°C maximum junction temperature and a thermal resistance of 100°C/W junction to ambient.

Electrical Characteristics

(V_{CC} = 5.5V, V_{IN} = 2.4V, T_J = 25°C, Figure 1, unless otherwise specified.)

Symbol	Parameter	Conditions	Min	Typ	Max	Units
I _{CC}	Supply Current					
	Off	V _{IN} = 0V		11	23	mA
	Peak	Pin 8 = 0V		28	54	mA
	Hold	Pin 8 Open		16	26	mA
V _{OH}	Input On Level	V _{CC} = 5.5V		1.4	2.4	V
		V _{CC} = 3.0V		1.2	1.6	V
V _{OL}	Input Off Level	V _{CC} = 5.5V	1.0	1.35		V
		V _{CC} = 3.0V	0.7	1.15		V
I _B	Input Current		-25	3	+25	μA
I _{OP}	Output Current					
	Peak	Pin 8 = 0V	-10	-22		mA
	Hold	Pin 8 Open	-1.5	-5		mA
V _S	Output Saturation Voltage	10 mA, V _{IN} = 0V		0.2	0.4	V
V _P	Sense Input					
	Peak Threshold	V _{CC} = 4.75V	350	386	415	mV
V _H	Hold Reference		88	94	102	mV
t	Time-out, t	t ÷ R _T C _T	90	100	110	%

Typical Performance Characteristics

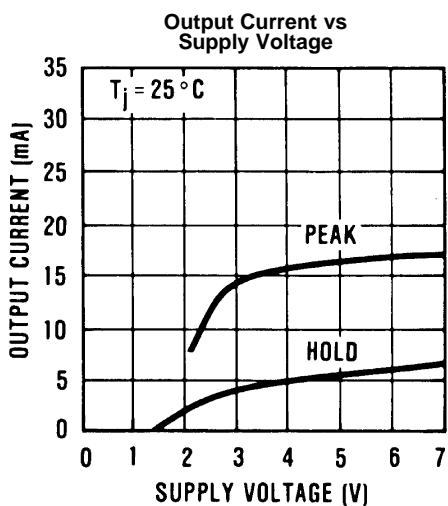

Figure 3.

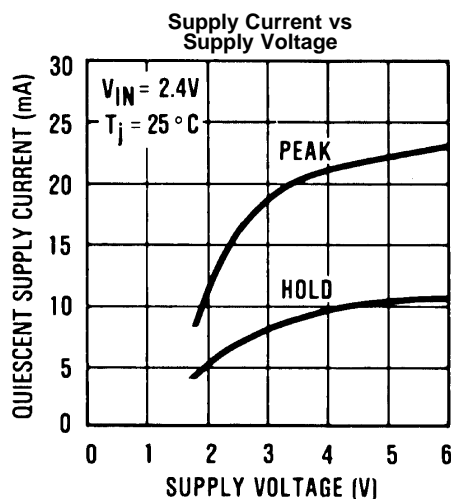

Figure 4.

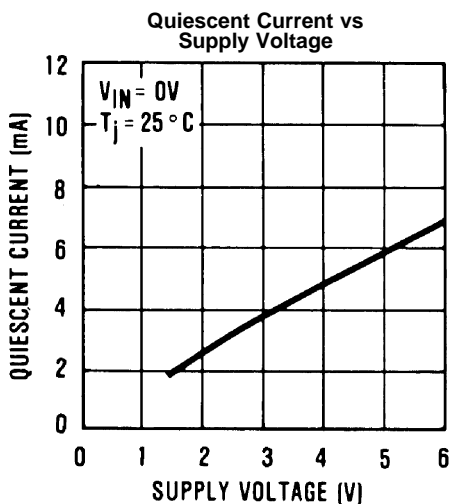

Figure 5.

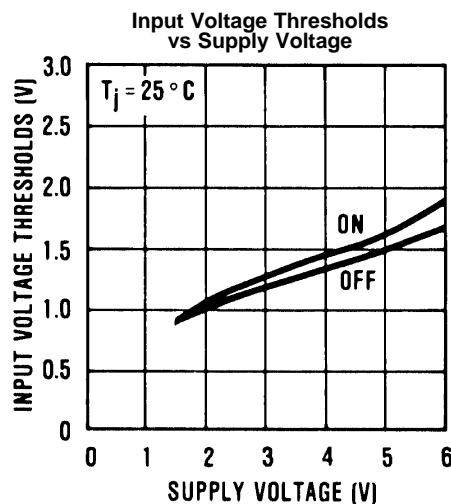

Figure 6.

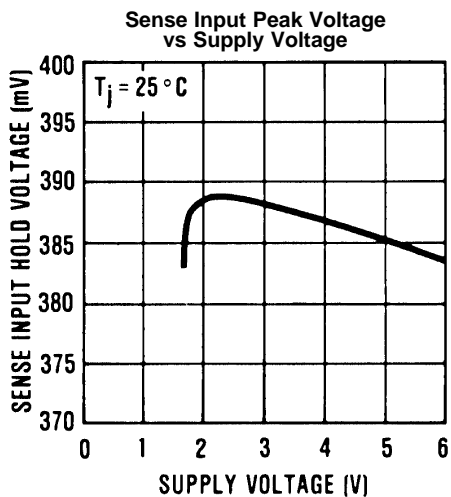

Figure 7.

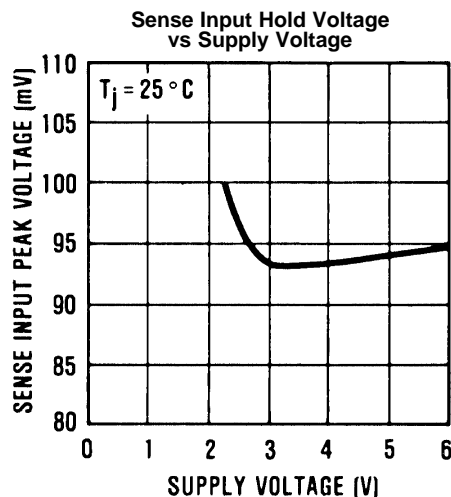

Figure 8.

Typical Performance Characteristics (continued)

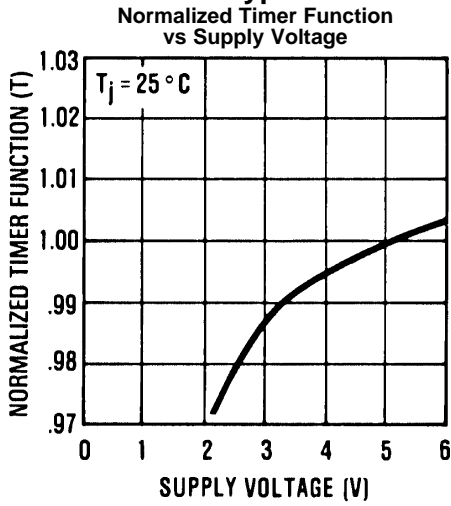

Figure 9.

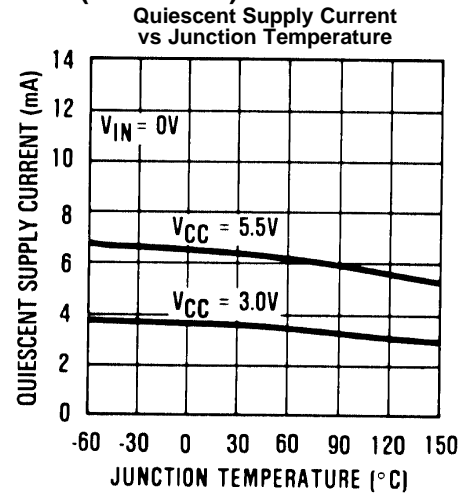

Figure 10.

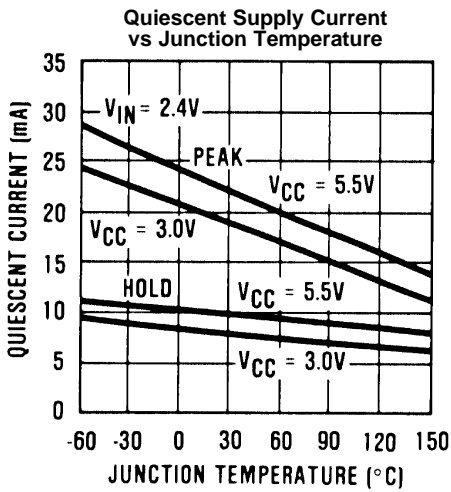

Figure 11.

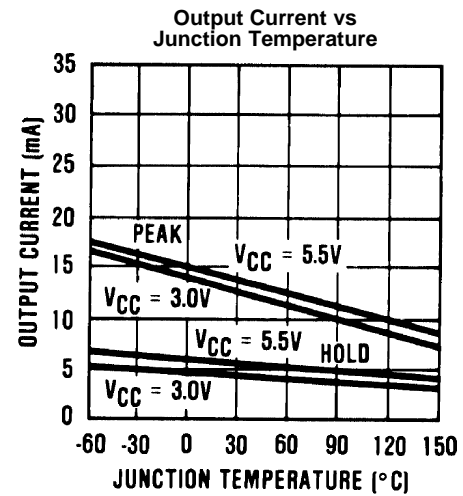

Figure 12.

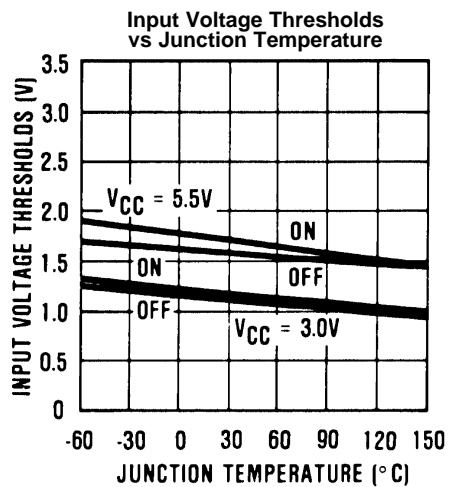

Figure 13.

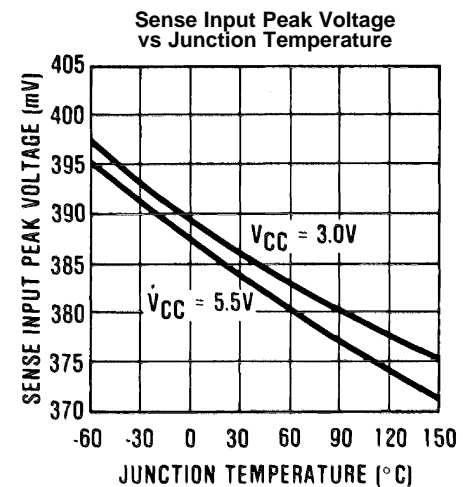

Figure 14.

Typical Performance Characteristics (continued)

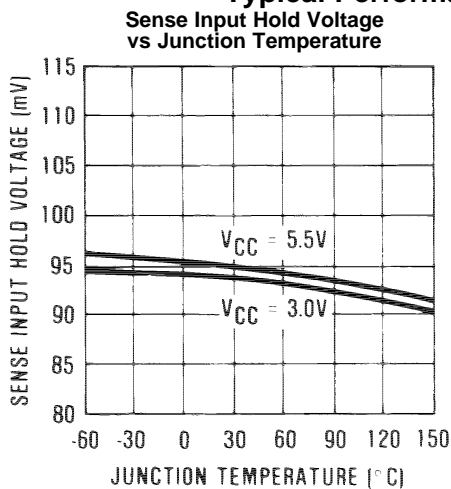

Figure 15.

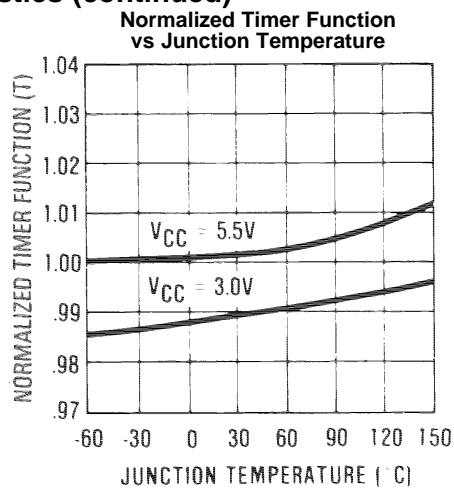

Figure 16.

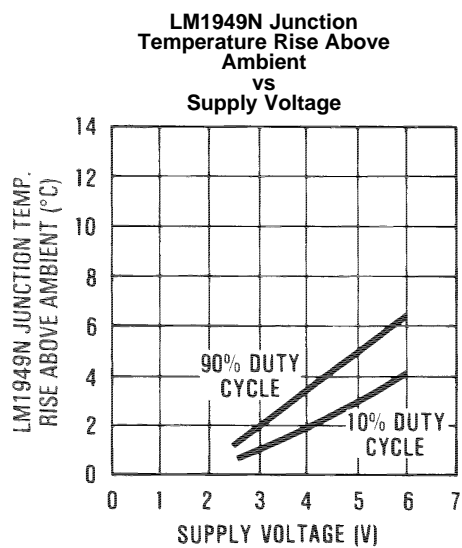

Figure 17.

Typical Circuit Waveforms

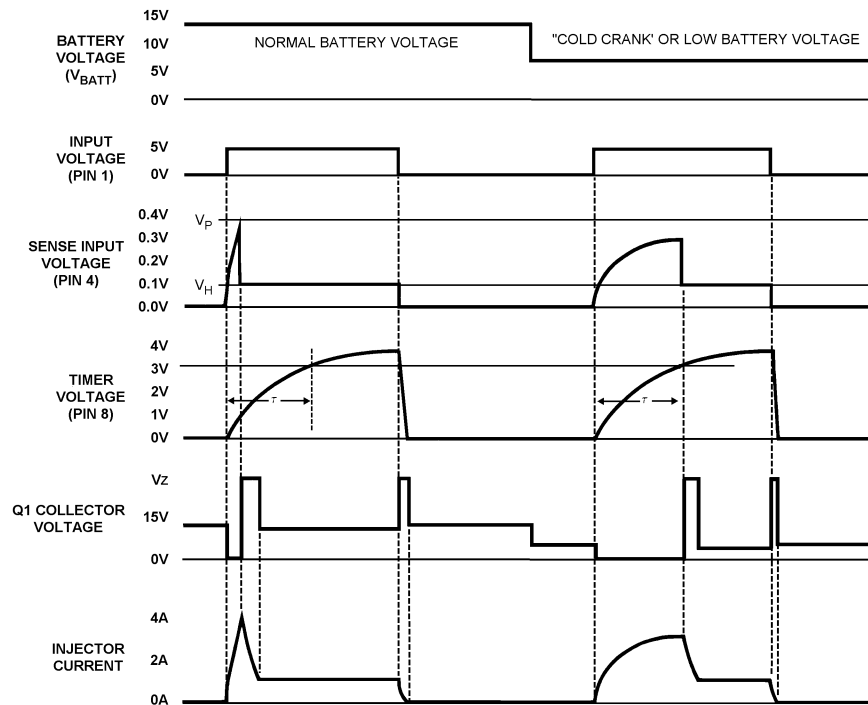

Figure 18.

APPLICATION HINTS

The injector driver integrated circuits were designed to be used in conjunction with an external controller. The LM1949 derives its input signal from either a control oriented processor (COPS™), microprocessor, or some other system. This input signal, in the form of a square wave with a variable duty cycle and/or variable frequency, is applied to Pin 1. In a typical system, input frequency is proportional to engine RPM. Duty cycle is proportional to the engine load. The circuits discussed are suitable for use in either open or closed loop systems. In closed loop systems, the engine exhaust is monitored and the air-to-fuel mixture is varied (via the duty cycle) to maintain a perfect, or stoichiometric, ratio.

INJECTORS

Injectors and solenoids are available in a vast array of sizes and characteristics. Therefore, it is necessary to be able to design a drive system to suit each type of solenoid. The purpose of this section is to enable any system designer to use and modify the LM1949 and associated circuitry to meet the system specifications.

Fuel injectors can usually be modeled by a simple RL circuit. Figure 19 shows such a model for a typical fuel injector. In actual operation, the value of L_1 will depend upon the status of the solenoid. In other words, L_1 will change depending upon whether the solenoid is open or closed. This effect, if pronounced enough, can be a valuable aid in determining the current necessary to open a particular type of injector. The change in inductance manifests itself as a breakpoint in the initial rise of solenoid current. The waveforms at the sense input show this occurring at approximately 130 mV. Thus, the current necessary to overcome the constrictive forces of that particular injector is 1.3 amperes.

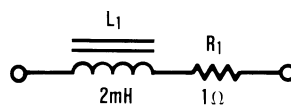

Figure 19. Model of a Typical Fuel Injector

PEAK AND HOLD CURRENTS

The peak and hold currents are determined by the value of the sense resistor R_S . The driver IC, when initiated by a logic 1 signal at Pin 1, initially drives Darlington transistor Q_1 into saturation. The injector current will rise exponentially from zero at a rate dependent upon L_1 , R_1 , the battery voltage and the saturation voltage of Q_1 . The drop across the sense resistor is created by the solenoid current, and when this drop reaches the peak threshold level, typically 385 mV, the IC is tripped from the peak state into the hold state. The IC now behaves more as an op amp and drives Q_1 within a closed loop system to maintain the hold reference voltage, typically 94 mV, across R_S . Once the injector current drops from the peak level to the hold level, it remains there for the duration of the input signal at Pin 1. This mode of operation is preferable when working with solenoids, since the current required to overcome kinetic and constriction forces is often a factor of four or more times the current necessary to hold the injector open. By holding the injector current at one fourth of the peak current, power dissipation in the solenoids and Q_1 is reduced by at least the same factor.

In the circuit of [Figure 1](#), it was known that the type of injector shown opens when the current exceeds 1.3 amps and closes when the current then falls below 0.3 amps. In order to guarantee injector operation over the life and temperature range of the system, a peak current of approximately 4 amps was chosen. This led to a value of R_S of 0.1Ω . Dividing the peak and hold thresholds by this factor gives peak and hold currents through the solenoid of 3.85 amps and 0.94 amps respectively.

Different types of solenoids may require different values of current. The sense resistor R_S may be changed accordingly. An 8-amp peak injector would use R_S equal to $.05\Omega$, etc. Note that for large currents above one amp, IR drops within the component leads or printed circuit board may create substantial errors unless appropriate care is taken. The sense input and sense ground leads (Pins 4 and 5 respectively), should be Kelvin connected to R_S . High current should not be allowed to flow through any part of these traces or connections. An easy solution to this problem on double-sided PC boards (without plated-through holes) is to have the high current trace and sense trace attach to the R_S lead from opposite sides of the board.

TIMER FUNCTION

The purpose of the timer function is to limit the power dissipated by the injector or solenoid under certain conditions. Specifically, when the battery voltage is low due to engine cranking, or just undercharged, there may not be sufficient voltage available for the injector to achieve the peak current. In the [Figure 18](#) waveforms under the low battery condition, the injector current can be seen to be leveling out at 3 amps, or 1 amp below the normal threshold. Since continuous operation at 3 amps may overheat the injectors, the timer function on the IC will force the transition into the hold state after one time constant (the time constant is equal to $R_T \times C_T$), or when the voltage on the TIMER pin (Pin 8) is greater than typically $V_{SUPPLY} \times 63\%$. The timer is reset at the end of each input pulse. For systems where the timer function is not needed, it can be disabled by grounding the TIMER Pin (Pin 8). For systems where the initial peak state is not required, (i.e., where the solenoid current rises immediately to the hold level), the timer can be used to disable the peak function. This is done by setting the time constant equal to zero, (i.e., $C_T = 0$). Leaving R_T in place is recommended. The timer will then complete its time-out and disable the peak condition before the solenoid current has had a chance to rise above the hold level.

The actual range of the timer in injection systems will probably never vary much from the 3.9 milliseconds shown in [Figure 1](#). However, the actual useful range of the timer extends from microseconds to seconds, depending on the component values chosen. The useful range of R_T is approximately 1k to 240k. The capacitor C_T is limited only by stray capacitances for low values and by leakages for large values.

The timing capacitor is reset (discharged) when the IN pin (Pin 1) is below the $V_{OL(MIN)}$ threshold. The capacitor reset time at the end of each controller pulse is determined by the supply voltage and the timing capacitor value. The IC resets the capacitor to an initial voltage (V_{BE}) by discharging it with a current of approximately 15 mA. Thus, a $0.1 \mu\text{F}$ cap is reset in approximately 25 μs .

COMPENSATION

Compensation of the error amplifier provides stability for the circuit during the hold state. External compensation (from Pin 2 to Pin 3) allows each design to be tailored for the characteristics of the system and/or type of Darlington power device used. In the vast majority of designs, the value or type of the compensation capacitor is not critical. Values of 100 pF to $0.1 \mu\text{F}$ work well with the circuit of [Figure 1](#). The value shown of $0.1 \mu\text{F}$ (disc) provides a close optimum in choice between economy, speed, and noise immunity. In some systems, increased phase and gain margin may be acquired by bypassing the collector of Q_1 to ground with an appropriately rated $0.1 \mu\text{F}$ capacitor. This is, however, rarely necessary.

FLYBACK ZENER

The purpose of zener Z_1 is twofold. Since the load is inductive, a voltage spike is produced at the collector of Q_1 anytime the injector is reduced. This occurs at the peak-to-hold transition, (when the current is reduced to one fourth of its peak value), and also at the end of each input pulse, (when the current is reduced to zero). The zener provides a current path for the inductive kickback, limiting the voltage spike to the zener value and preventing Q_1 from damaging voltage levels. Thus, the rated zener voltage at the system peak current must be less than the minimum breakdown of Q_1 . Also, even while Z_1 is conducting the majority of the injector current during the peak-to-hold transition (see [Figure 20](#)), Q_1 is operating at the hold current level. This fact is easily overlooked and, as described in the following text, can be corrected if necessary. Since the error amplifier in the IC demands 94 mV across R_S , Q_1 will be biased to provide exactly that. Thus, the safe operating area (SOA) of Q_1 must include the hold current with a V_{CE} of Z_1 volts. For systems where this is not desired, the zener anode may be reconnected to the top of R_S as shown in [Figure 21](#). Since the voltage across the sense resistor now accurately portrays the injector current at all times, the error amplifier keeps Q_1 off until the injector current has decayed to the proper value. The disadvantage of this particular configuration is that the ungrounded zener is more difficult to heat sink if that becomes necessary.

The second purpose of Z_1 is to provide system transient protection. Automotive systems are susceptible to a vast array of voltage transients on the battery line. Though their duration is usually only milliseconds long, Q_1 could suffer permanent damage unless buffered by the injector and Z_1 . There is one reason why a zener is preferred over a clamp diode back to the battery line, the other reason being long decay times.

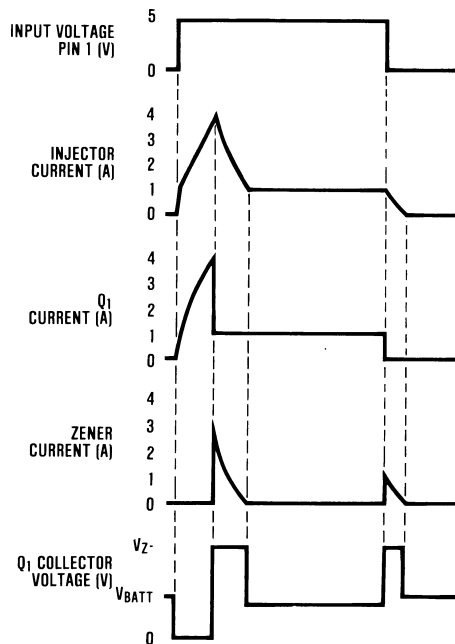

Figure 20. Circuit Waveforms

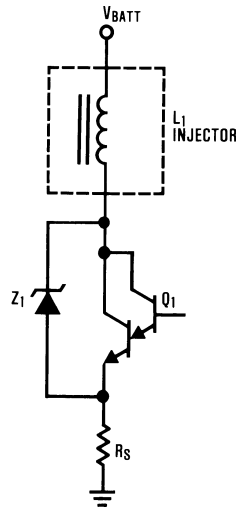

Figure 21. Alternate Configuration for Zener Z1

POWER DISSIPATION

The power dissipation of the system shown in [Figure 1](#) is dependent upon several external factors, including the frequency and duty cycle of the input waveform to Pin 1. Calculations are made more difficult since there are many discontinuities and breakpoints in the power waveforms of the various components, most notably at the peak-to-hold transition. Some generalizations can be made for normal operation. For example, in a typical cycle of operation, the majority of dissipation occurs during the hold state. The hold state is usually much longer than the peak state, and in the peak state nearly all power is stored as energy in the magnetic field of the injector, later to be dumped mostly through the zener. While this assumption is less accurate in the case of low battery voltage, it nevertheless gives an unexpectedly accurate set of approximations for general operation.

The following nomenclature refers to [Figure 1](#). Typical values are given in parentheses:

- R_S = Sense Resistor (0, 1 Ω)
- V_H = Sense Input Hold Voltage (.094V)
- V_P = Sense Input Peak Voltage (.385V)
- V_Z = Z_1 Zener Breakdown Voltage (33V)
- V_{BATT} = Battery Voltage (14V)
- L_1 = Injector Inductance (.002H)
- R_1 = Injector Resistance (1 Ω)
- n = Duty Cycle of Input Voltage of Pin 1 (0 to 1)
- f = Frequency of Input (10 Hz to 200 Hz)

Q₁ Power Dissipation:

$$P_Q \approx n \cdot V_{BATT} \cdot \frac{V_H}{R_S} \text{ Watts}$$

Zener Dissipation:

$$P_Z \approx V_Z \cdot L_1 \cdot f \cdot \frac{(V_P^2 + V_H^2)}{((V_Z - V_{BATT}) \cdot R_S^2)} \text{ Watts}$$

Injector Dissipation:

$$P_I \approx n \cdot R_1 \cdot \frac{V_H^2}{R_S^2} \text{ Watts}$$

Sense Resistor:

$$P_R \approx n \frac{V_H^2}{R_S^2} \text{ Watts}$$

$$P_R \text{ (worst case)} \approx n \frac{V_P^2}{R_S^2} \text{ Watts}$$

(1)

SWITCHING INJECTOR DRIVER CIRCUIT

The power dissipation of the system, and especially of Q₁, can be reduced by employing a switching injector driver circuit. Since the injector load is mainly inductive, transistor Q₁ can be rapidly switched on and off in a manner similar to switching regulators. The solenoid inductance will naturally integrate the voltage to produce the required injector current, while the power consumed by Q₁ will be reduced. A note of caution: The large amplitude switching voltages that are present on the injector can and do generate a tremendous amount of radio frequency interference (RFI). Because of this, switching circuits are not recommended. The extra cost of shielding can easily exceed the savings of reduced power. In systems where switching circuits are mandatory, extensive field testing is required to guarantee that RFI cannot create problems with engine control or entertainment equipment within the vicinity.

The LM1949 can be easily modified to function as a switcher. Accomplished with the circuit of [Figure 23](#), the only additional components required are two external resistors, R_A and R_B. Additionally, the zener needs to be reconnected, as shown, to R_S. The amount of ripple on the hold current is easily controlled by the resistor ratio of R_A to R_B. R_B is kept small so that sense input bias current (typically 0.3 mA) has negligible effect on V_H. Duty cycle and frequency of oscillation during the hold state are dependent on the injector characteristics, R_A, R_B, and the zener voltage as shown in the following equations.

$$\text{Hold Current} \approx \frac{V_H}{R_S}$$

$$\text{Minimum Hold Current} \approx \frac{(V_H - \frac{R_B}{R_A} \cdot V_Z)}{R_S}$$

$$\text{Ripple or } \Delta I \text{ Hold} \approx \frac{R_B}{R_A} \cdot V_Z \cdot \frac{1}{R_S}$$

$$f_o \approx \frac{R_S}{L_1} \cdot \frac{R_A}{R_B} \cdot \frac{V_{BATT}}{V_Z} \cdot (1 - \frac{V_{BATT}}{V_Z})$$

f_o = Hold State Oscillation Frequency

$$\text{Duty Cycle of } f_o \approx \frac{V_{BATT}}{V_Z}$$

Component Power Dissipation

$$P_Q \approx n \cdot (1 - \frac{V_{BATT}}{V_Z}) \cdot \frac{V_{SAT}}{R_S} \cdot V_H$$

$$V_{SAT} = Q_1 \text{ Saturation Volt @ } \sim 1 \text{ Amp (1.5V)}$$

$$P_Z \approx n \cdot \frac{V_{BATT} \cdot V_H}{R_S}$$

$$P_{RA} \approx \frac{V_B \cdot V_Z}{R_1}$$

(2)

As shown, the power dissipation by Q_1 in this manner is substantially reduced. Measurements made with a thermocouple on the bench indicated better than a fourfold reduction in power in Q_1 . However, the power dissipation of the zener (which is independent of the zener voltage chosen) is increased over the circuit of Figure 1.

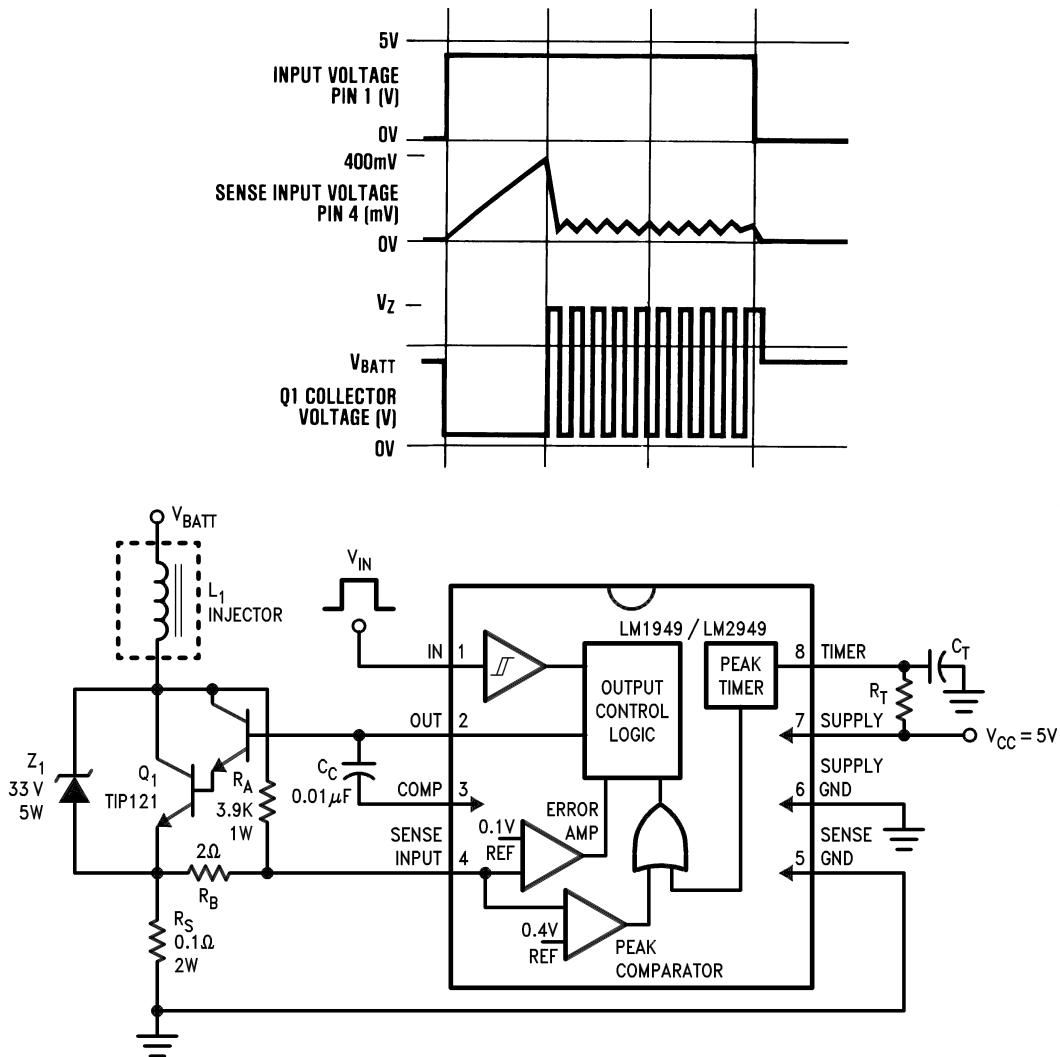

Figure 22. Switching Application Circuit

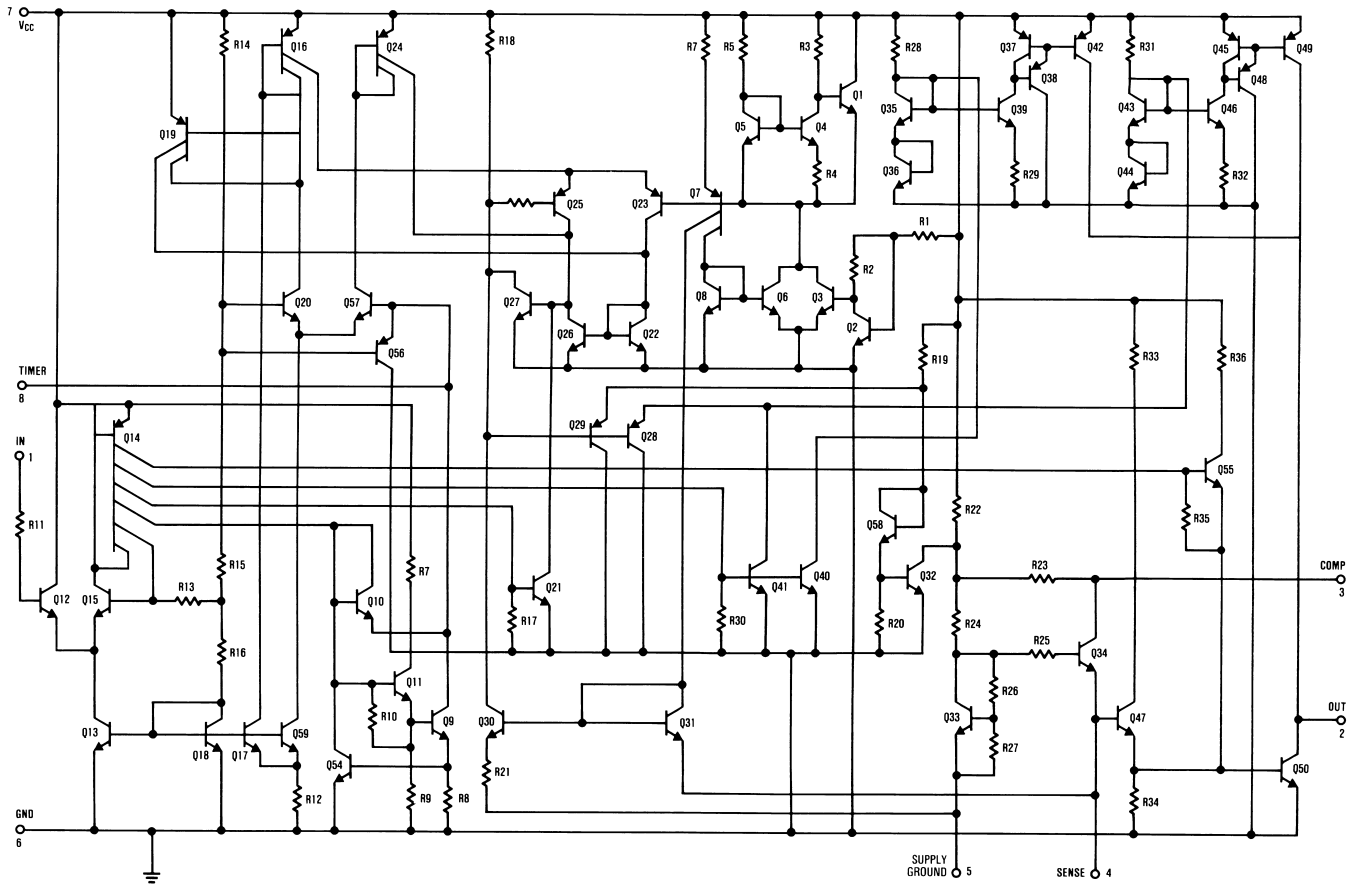

Figure 23. LM1949 Simplified Internal Schematic

REVISION HISTORY

Changes from Revision B (March 2013) to Revision C	Page
• Changed layout of National Data Sheet to TI format	12

PACKAGING INFORMATION

Orderable Device	Status (1)	Package Type	Package Drawing	Pins	Package Qty	Eco Plan (2)	Lead/Ball Finish (6)	MSL Peak Temp (3)	Op Temp (°C)	Device Marking (4/5)	Samples
LM1949N/NOPB	ACTIVE	PDIP	P	8	40	Green (RoHS & no Sb/Br)	CU SN	Level-1-NA-UNLIM	-55 to 125	LM 1949N	Samples

(1) The marketing status values are defined as follows:

ACTIVE: Product device recommended for new designs.

LIFEBUY: TI has announced that the device will be discontinued, and a lifetime-buy period is in effect.

NRND: Not recommended for new designs. Device is in production to support existing customers, but TI does not recommend using this part in a new design.

PREVIEW: Device has been announced but is not in production. Samples may or may not be available.

OBSELETE: TI has discontinued the production of the device.

(2) Eco Plan - The planned eco-friendly classification: Pb-Free (RoHS), Pb-Free (RoHS Exempt), or Green (RoHS & no Sb/Br) - please check <http://www.ti.com/productcontent> for the latest availability information and additional product content details.

TBD: The Pb-Free/Green conversion plan has not been defined.

Pb-Free (RoHS): TI's terms "Lead-Free" or "Pb-Free" mean semiconductor products that are compatible with the current RoHS requirements for all 6 substances, including the requirement that lead not exceed 0.1% by weight in homogeneous materials. Where designed to be soldered at high temperatures, TI Pb-Free products are suitable for use in specified lead-free processes.

Pb-Free (RoHS Exempt): This component has a RoHS exemption for either 1) lead-based flip-chip solder bumps used between the die and package, or 2) lead-based die adhesive used between the die and leadframe. The component is otherwise considered Pb-Free (RoHS compatible) as defined above.

Green (RoHS & no Sb/Br): TI defines "Green" to mean Pb-Free (RoHS compatible), and free of Bromine (Br) and Antimony (Sb) based flame retardants (Br or Sb do not exceed 0.1% by weight in homogeneous material)

(3) MSL, Peak Temp. - The Moisture Sensitivity Level rating according to the JEDEC industry standard classifications, and peak solder temperature.

(4) There may be additional marking, which relates to the logo, the lot trace code information, or the environmental category on the device.

(5) Multiple Device Markings will be inside parentheses. Only one Device Marking contained in parentheses and separated by a "-" will appear on a device. If a line is indented then it is a continuation of the previous line and the two combined represent the entire Device Marking for that device.

(6) Lead/Ball Finish - Orderable Devices may have multiple material finish options. Finish options are separated by a vertical ruled line. Lead/Ball Finish values may wrap to two lines if the finish value exceeds the maximum column width.

Important Information and Disclaimer:The information provided on this page represents TI's knowledge and belief as of the date that it is provided. TI bases its knowledge and belief on information provided by third parties, and makes no representation or warranty as to the accuracy of such information. Efforts are underway to better integrate information from third parties. TI has taken and continues to take reasonable steps to provide representative and accurate information but may not have conducted destructive testing or chemical analysis on incoming materials and chemicals. TI and TI suppliers consider certain information to be proprietary, and thus CAS numbers and other limited information may not be available for release.

In no event shall TI's liability arising out of such information exceed the total purchase price of the TI part(s) at issue in this document sold by TI to Customer on an annual basis.

P (R-PDIP-T8)

PLASTIC DUAL-IN-LINE PACKAGE



- NOTES:
- A. All linear dimensions are in inches (millimeters).
 - B. This drawing is subject to change without notice.
 - C. Falls within JEDEC MS-001 variation BA.

IMPORTANT NOTICE

Texas Instruments Incorporated and its subsidiaries (TI) reserve the right to make corrections, enhancements, improvements and other changes to its semiconductor products and services per JESD46, latest issue, and to discontinue any product or service per JESD48, latest issue. Buyers should obtain the latest relevant information before placing orders and should verify that such information is current and complete. All semiconductor products (also referred to herein as "components") are sold subject to TI's terms and conditions of sale supplied at the time of order acknowledgment.

TI warrants performance of its components to the specifications applicable at the time of sale, in accordance with the warranty in TI's terms and conditions of sale of semiconductor products. Testing and other quality control techniques are used to the extent TI deems necessary to support this warranty. Except where mandated by applicable law, testing of all parameters of each component is not necessarily performed.

TI assumes no liability for applications assistance or the design of Buyers' products. Buyers are responsible for their products and applications using TI components. To minimize the risks associated with Buyers' products and applications, Buyers should provide adequate design and operating safeguards.

TI does not warrant or represent that any license, either express or implied, is granted under any patent right, copyright, mask work right, or other intellectual property right relating to any combination, machine, or process in which TI components or services are used. Information published by TI regarding third-party products or services does not constitute a license to use such products or services or a warranty or endorsement thereof. Use of such information may require a license from a third party under the patents or other intellectual property of the third party, or a license from TI under the patents or other intellectual property of TI.

Reproduction of significant portions of TI information in TI data books or data sheets is permissible only if reproduction is without alteration and is accompanied by all associated warranties, conditions, limitations, and notices. TI is not responsible or liable for such altered documentation. Information of third parties may be subject to additional restrictions.

Resale of TI components or services with statements different from or beyond the parameters stated by TI for that component or service voids all express and any implied warranties for the associated TI component or service and is an unfair and deceptive business practice. TI is not responsible or liable for any such statements.

Buyer acknowledges and agrees that it is solely responsible for compliance with all legal, regulatory and safety-related requirements concerning its products, and any use of TI components in its applications, notwithstanding any applications-related information or support that may be provided by TI. Buyer represents and agrees that it has all the necessary expertise to create and implement safeguards which anticipate dangerous consequences of failures, monitor failures and their consequences, lessen the likelihood of failures that might cause harm and take appropriate remedial actions. Buyer will fully indemnify TI and its representatives against any damages arising out of the use of any TI components in safety-critical applications.

In some cases, TI components may be promoted specifically to facilitate safety-related applications. With such components, TI's goal is to help enable customers to design and create their own end-product solutions that meet applicable functional safety standards and requirements. Nonetheless, such components are subject to these terms.

No TI components are authorized for use in FDA Class III (or similar life-critical medical equipment) unless authorized officers of the parties have executed a special agreement specifically governing such use.

Only those TI components which TI has specifically designated as military grade or "enhanced plastic" are designed and intended for use in military/aerospace applications or environments. Buyer acknowledges and agrees that any military or aerospace use of TI components which have **not** been so designated is solely at the Buyer's risk, and that Buyer is solely responsible for compliance with all legal and regulatory requirements in connection with such use.

TI has specifically designated certain components as meeting ISO/TS16949 requirements, mainly for automotive use. In any case of use of non-designated products, TI will not be responsible for any failure to meet ISO/TS16949.

Products

Audio	www.ti.com/audio
Amplifiers	amplifier.ti.com
Data Converters	dataconverter.ti.com
DLP® Products	www.dlp.com
DSP	dsp.ti.com
Clocks and Timers	www.ti.com/clocks
Interface	interface.ti.com
Logic	logic.ti.com
Power Mgmt	power.ti.com
Microcontrollers	microcontroller.ti.com
RFID	www.ti-rfid.com
OMAP Applications Processors	www.ti.com/omap
Wireless Connectivity	www.ti.com/wirelessconnectivity

Applications

Automotive and Transportation	www.ti.com/automotive
Communications and Telecom	www.ti.com/communications
Computers and Peripherals	www.ti.com/computers
Consumer Electronics	www.ti.com/consumer-apps
Energy and Lighting	www.ti.com/energy
Industrial	www.ti.com/industrial
Medical	www.ti.com/medical
Security	www.ti.com/security
Space, Avionics and Defense	www.ti.com/space-avionics-defense
Video and Imaging	www.ti.com/video

TI E2E Community

e2e.ti.com